



product_datasheet_title

DL SLIM DN 105 6 W 3000 K WT

DOWNLIGHT SLIM ROUND | Flat downlights with integrated driver, round shape



technical_data

ELECTRICAL DATA

Nominal wattage	6.00 W
Nominal voltage	220...240 V
Mains frequency	50...60 Hz
Nominal current	58 mA
Inrush current	6 A
Inrush current time T_{h50}	120 μ s
Max. number of luminaires per miniature circuit breaker B16	72
Max. number of luminaires per miniature circuit breaker C10	60
Max. number of luminaires per miniature circuit breaker C16	96
Power factor λ	0.50
Total harmonic distortion	< 20 %
Protection class	II
Operating mode	Integrated LED driver

PHOTOMETRICAL DATA

Luminous flux	420 lm
Luminous efficacy	70 lm/W
Color temperature	3000 K
Light color (designation)	Warm White
Color rendering index Ra	> 80
Standard deviation of color matching	< 6 sdc _m
Luminous intensity	-
Flickering metric (Pst LM)	-
Stroboscope effect metric (SVM)	-
Photobiological safety group acc. to EN62778	RG0
Photobiological safety group acc. to EN62471	RG0
Beam angle	120 °

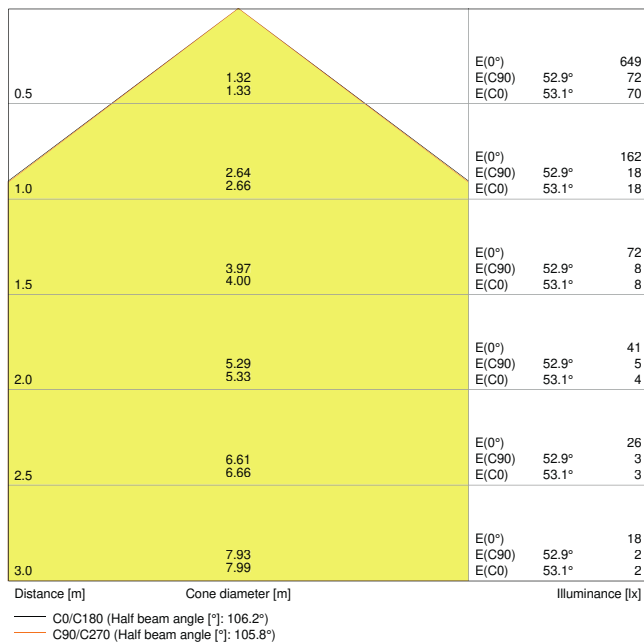

4058075052222 DL SLIM DN105 6W 3000K WT IP20

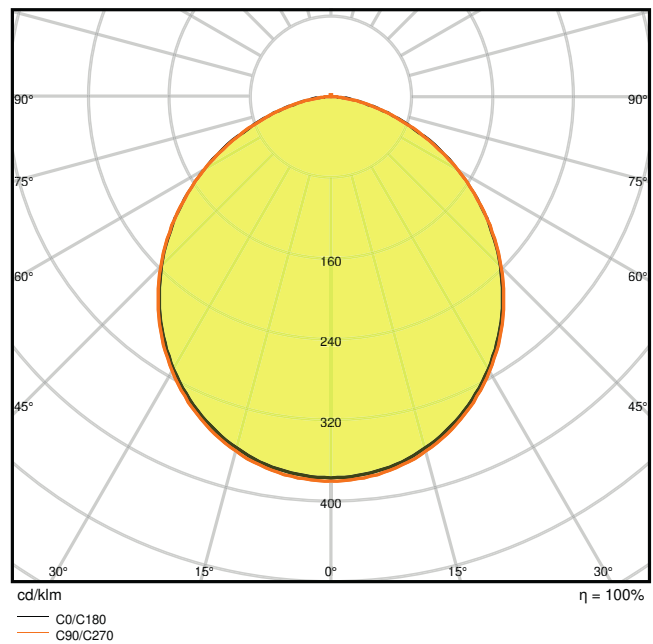

4058075052222 DL SLIM DN105 6W 3000K WT IP20

DIMENSIONS & WEIGHT

Diameter	118.00 mm
Height	30.00 mm
Product weight	158.00 g

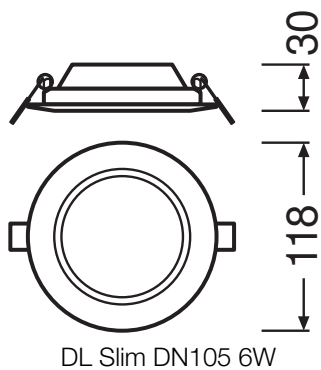

MATERIALS & COLORS

Product color	White
---------------	-------

Housing color	White
Body material	Polycarbonate (PC)
Cover material	Polycarbonate (PC)
Light emitting surface material	Polycarbonate (PC)
Glow Wire Test according to IEC 60695-2-12	650 °C
Mercury content	0.0 mg

APPLICATION & MOUNTING

Ambient temperature range	-20...+50 °C
Temperature range at storage	-30...+70 °C
Type of connection	Screwless terminal, 2-Pole
Type of protection	IP20
Protection class IK (shock resistance)	IK03
Dimmable	no
Mounting type	Recessed
Mounting location	Ceiling
Application environment	Indoor
Mounting diameter	105.00 mm
Mounting depth	50,0 mm
LED module replaceable	Not replaceable
With light source	Yes

LIFESPAN

Lifespan L70/B50 at 25 °C	30000 h ¹⁾
Lifespan L80/B10 at 25 °C	20000 h ¹⁾
Lifespan L90/B10 at 25 °C	12000 h
Number of switching cycles	50000

¹⁾ t[h]: L70 / B50 @ 25 °C (Ta), t[h]: L80 / B10 @ 25 °C (Ta), t[h]: L90 / B10 @ 25 °C (Ta)

CONTROL GEAR

Output current	180 mA
ECG - Output ripple current	< 6.5 %

CERTIFICATES & STANDARDS



Standards	CE / CB / EAC
Luminaire with limited surface temperature, "D sign"	No

Ball shot safe	No
----------------	----









ADDITIONAL PRODUCT DATA







Number of illuminants	Not relevant
-----------------------	--------------

Accessories Optional

product_image	product_name	product_ean
	DL SLIM FRAME DN 105 WT	4058075052406
	DL SLIM FRAME DN 105 WT	4058075079151

download_data

Documents and certificates		document_name
	Addon Technical Information	LSI DL SLIM
	Installation guide	User Instruction Downlight LED Slim
	On-Pack-Info	Legal Insert Downlight Slim
	Declarations Of Conformity CE	CE Certificate downlight Slim
	Declarations Of Conformity UKCA	DL SLIM WT IP20
Photometric and lighting design files		document_name
	IES file (IES)	DL SLIM DN105 6W 3000K WT IP20
	LDT file (Eulumdat)	DL SLIM DN105 6W 3000K WT IP20
	ULD file (DIALux)	DOWNLIGHTSLIMROUND1056W3000KWT

Photometric and lighting design files		document_name
	ROLF file (RELUX)	DL SLIM DN105 6W-3000K
	UGR file (UGR table)	4058075052222 DL SLIM DN105 6W 3000K WT IP20
	LDC typ cone	4058075052222 DL SLIM DN105 6W 3000K WT IP20
	LDC typ polar	4058075052222 DL SLIM DN105 6W 3000K WT IP20
CAD/BIM files		document_name
	BIM_Revit_3D	Downlight Slim Round
	CAD_STEP_3D	DL SLIM DN 105

logistical_data

product_code	packaging_unit	dimensions	weight	volume
4058075078970	Folding box 1	45 mm x 145 mm x 145 mm	192.00 g	0.95 dm ³
4058075078987	Shipping box 6	290 mm x 155 mm x 165 mm	1317.00 g	7.42 dm ³

logistical_data_text

additional_catalog_information

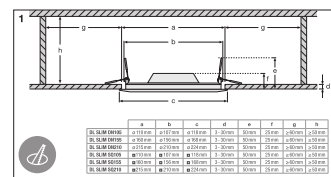
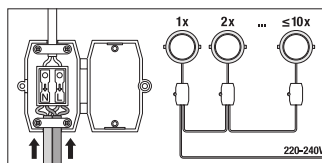
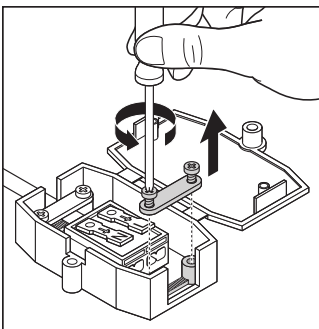

disclaimer_title

disclaimer_text